

TECHNICAL

DUALDRI

DOUBLE BLADE JET DRYER

A266DD-W (WHITE) HD15100

A266DD-S (METALLIC SILVER) HD15101

Low Noise , Rapid Dry

Dries hands in seconds

Dual-Dri dries hands completely in a matter of seconds blasting high velocity air streams to both sides of your hands simultaneously reducing the dry time by half.

Lowest running costs

Keep your cost to a minimum with Dual-Dri. Dual-Dri provides you with significantly lower costs than conventional dryers and paper towels.

Clean and hygienic

Touch-free, inlet air filtration, anti-bacterial treated plastics and no soiled paper towel litter. Dual-Dri is the best option for health and well being.

Low impact on the environment

Life Cycle Assessment Studies show that electric hand dryers are a better choice than paper based products on energy usage alone, without considering the environmental impact of the manufacture and disposal of paper.



OPERATION	CONSTRUCTION	EMC COMPLIANCE
Automatic Touch free , infra-red control	Enclosure - ABS with anti-bacterial additive	Z184
Noise level - 65-68 dB	Colour - White or metallic silver	
Dry Time - 8-12 seconds	Water ingress protection - IPx4	WARRANTY
Air Speed - 95 -100 M/S	Air Filter - Washable type/ Hepa	Labour - 5 years (factory)
Air Flow - 65 CFM	Class - II	Parts - 2 years
ELECTRICAL	DIMENSIONS AND SIZE	
Voltage - 220-240 V AC 50/60 Hz	Net weight - 9.5 kg	
Rated Power - 1000-1300 W	Depth - 219 mm	
Motor Type - Induction DC brushless	Size - 300 mm(wide) 670 mm (height)	

ARDRICH HAND DRYERS

DUALDRI

DOUBLE BLADE JET DRYER

A266DD-W (WHITE)

A266DD-S (METALLIC SILVER)



Recommended Heights (mm)		Male	Female	Child/disabled
A	Dryer Top	1050	974	876
B	Mounting Plate (bottom)	890	814	716
C	Cable entry (centre)	783	707	609
D	Outlet box (centre)	657	581	483
E	Floor to bottom of dryer	380	304	206

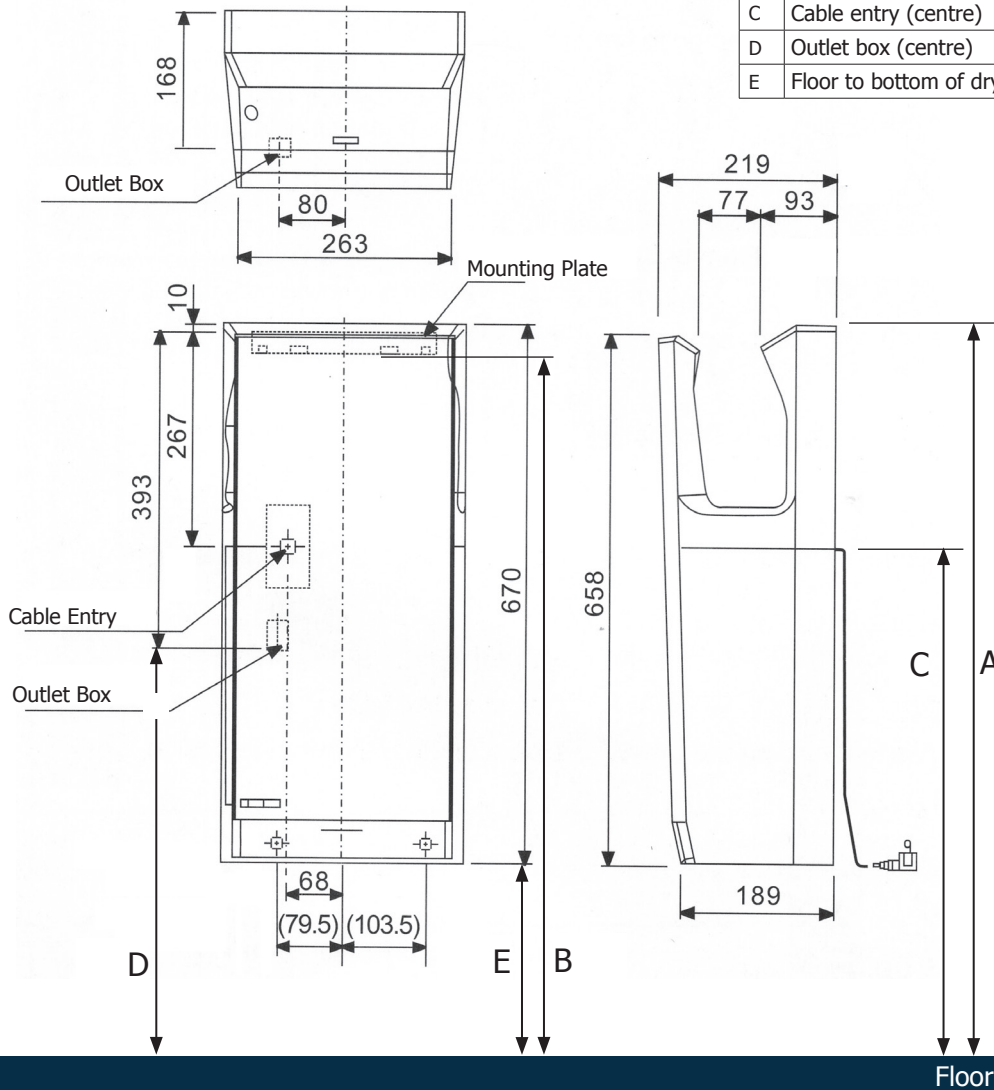

Dryer Dimensions

Height - 670 mm
 Width - 263 mm
 Depth - 219 mm

Minimum clearances to be maintained around the dryer

Both sides - 200 mm
 Above - 200 mm
 Below - 150 mm